

Two-element Parasitic Delta-Loop Array for 40 Meters

by WB3HUZ, 25 March 2009

The two-element parasitic delta-loop array was designed for a center frequency of 7.160 MHz using CocoaNEC, a NEC 2 based antenna modeling system. All model runs used the following parameters.

Ground Relative Dielectric Constant: 20
Ground Conductivity: 0.0303 mhos/m
Norton/Sommerfield Approximation
Wire Size for all elements: #12 AWG
Height of top of loops: 70 feet

The dimensions, feed and switching arrangements are shown in **Figure 1**. The operation of the array is also described in the figure.

Tuning stub lengths and transformer lengths were calculated by hand. Modeling simulations were run at the frequencies listed in **Table 1** below. Feedpoint impedances from the models were then run through W9CF's transmission line calculator Java applet to determine the impedances at the end of the 75-Ohm matching transformer. These values were then fed back into the applet to determine the impedance and SWR at the end of 100 feet of 9913 coax (the estimated length to be used when the antenna is installed). Coax losses in the 75 and 50 sections were pulled from the applet too.

Azimuth and elevation plots at several frequencies from 7.1 to 7.3 MHz were plotted from simulation runs. Each provides a comparison to a one-half wave dipole at 65 feet above ground. The azimuth plots were taken at an elevation angle of 30 degrees, the same angle at the forward-lobe take-off angle of the array. The plots are shown **Figures 2 - 7**.

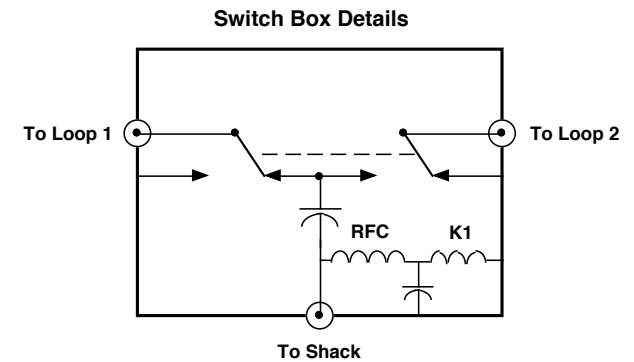
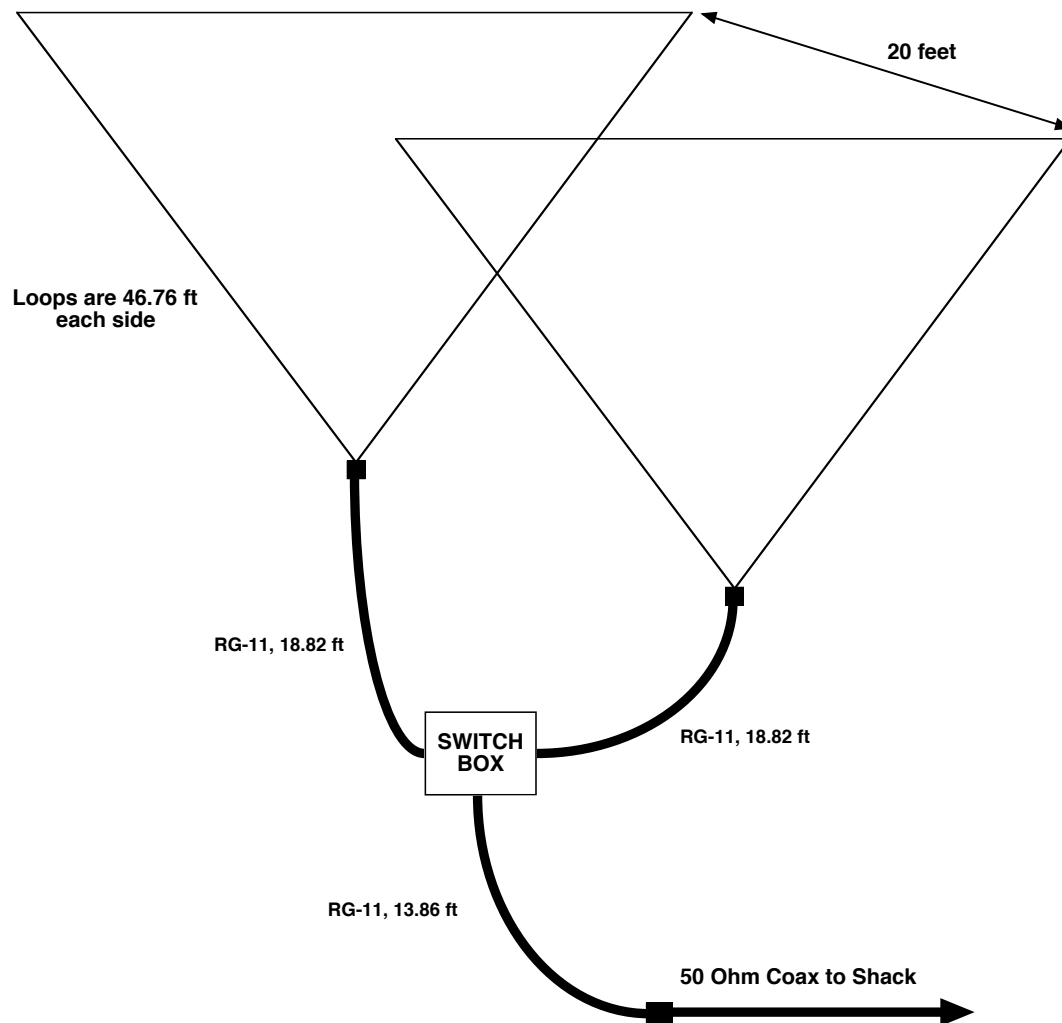

The two lengths of RG-11 (0.85 VF) connected to the driven loop add up to 32.68 feet (18.82 and 13.68). This forms a one-quarter wavelength transformer that transforms the feedpoint impedance of $102.8 + j10.8$ Ohms to $53.91 + j0.04$ at the 50 Ohm cable connection point. (The lengths are 25.25 feet (14.61 and 10.64) for RG-11 with 0.66 VF.)

The undriven loop has the shorted 18.82 foot section of RG-11 connected to it. This places a 120 Ohm inductive load (or 2.66 uH) at the feedpoint. This load increases the electrical length making this loop a reflector.

The design center frequency is 7160 kHz.

Figure 1 - Array Layout

f (MHz)	X _i of Stub (Ω)	Z at end of 75 Ω Transformer (Ω)	SWR at 75 Ω	Loss in 75 Ohm Transformer (dB)	Z at end of 100 ft of 9913 Coax (Ω)	SWR at end of 100 ft of 9913 Coax	Loss in 100 ft of 9913 Coax (dB)	Total Loss (dB)	Gain (dBi)	F/B at 30° (dB)
7.1	117.23	82.21 + j30.67	1.5	0.18	30.30 + j14.77	1.88	0.43	0.61	11.4	10.2
7.125	118.63	72.33 + j9.34	1.15	0.15	40.1 + j13.06	1.45	0.38	0.53	11.38	13.5
7.135	119.05	66.57 + j4.71	1.15	0.15	43.63 + j10.58	1.32	0.37	0.52		
7.145	119.38	61.16 + j1.85	1.21	0.15	46.51 + j8.09	1.21	0.36	0.51		
7.16	120	53.91 - j0.04	1.39	0.14	49.25 - j3.01	1.07	0.35	0.49	11.25	20
7.17	120.35	49.94 - j0.43	1.5	0.14	50.06 - j0.42	1	0.35	0.49		
7.18	120.73	46.56 - j0.035	1.61	0.14	50.12 - j3.66	1.07	0.35	0.49		
7.19	121.1	43.74 + j0.06	1.71	0.15	49.54 - j6.5	1.13	0.35	0.5		
7.2	121.48	41.33 + j0.61	1.82	0.15	48.57 - j8.98	1.19	0.35	0.5	11.03	25
7.22	122.25	37.61 + j1.94	2	0.16	45.94 - j12.56	1.31	0.35	0.51		
7.24	123.1	34.94 + j3.33	2.15	0.17	43.07 - j14.65	1.4	0.36	0.53		
7.25	123.45	33.91 + j3.97	2.22	0.18	41.74 - j15.26	1.45	0.36	0.54	10.74	16
7.26	123.84	33.02 + j4.59	2.29	0.18	40.46 - j15.68	1.49	0.36	0.54		
7.28	124.62	31.49 + j5.8	2.4	0.19	38.05 - j16.08	1.57	0.37	0.56		
7.3	125.42	30.6 + j6.66	2.48	0.2	36.37 - j15.93	1.62	0.37	0.57	10.46	12.6

Table 1 - Array and feed System Characteristics

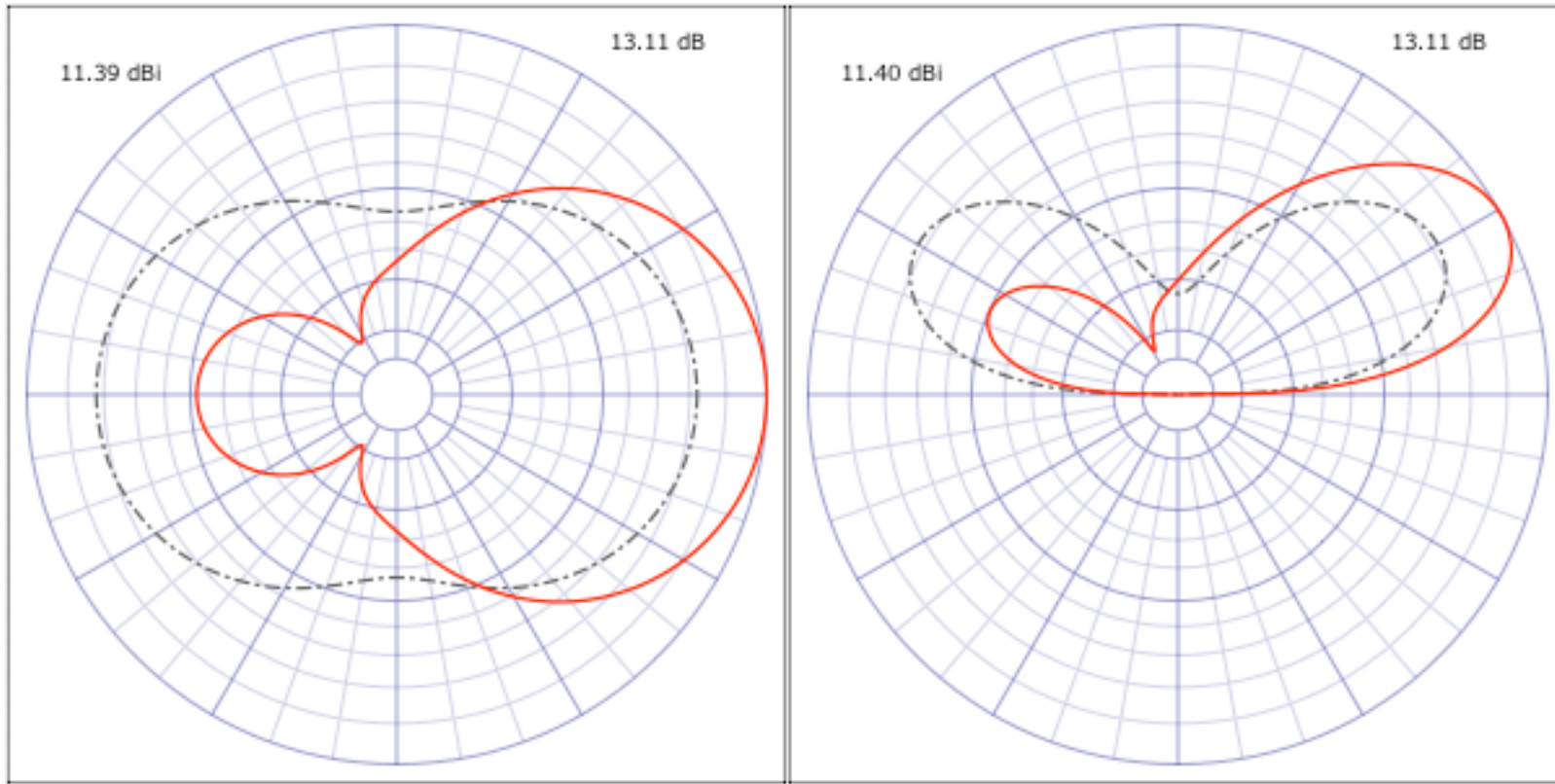

Figure 2 - Array Radiation Patterns at 7.1 MHz (Red is array, dashed line is dipole)

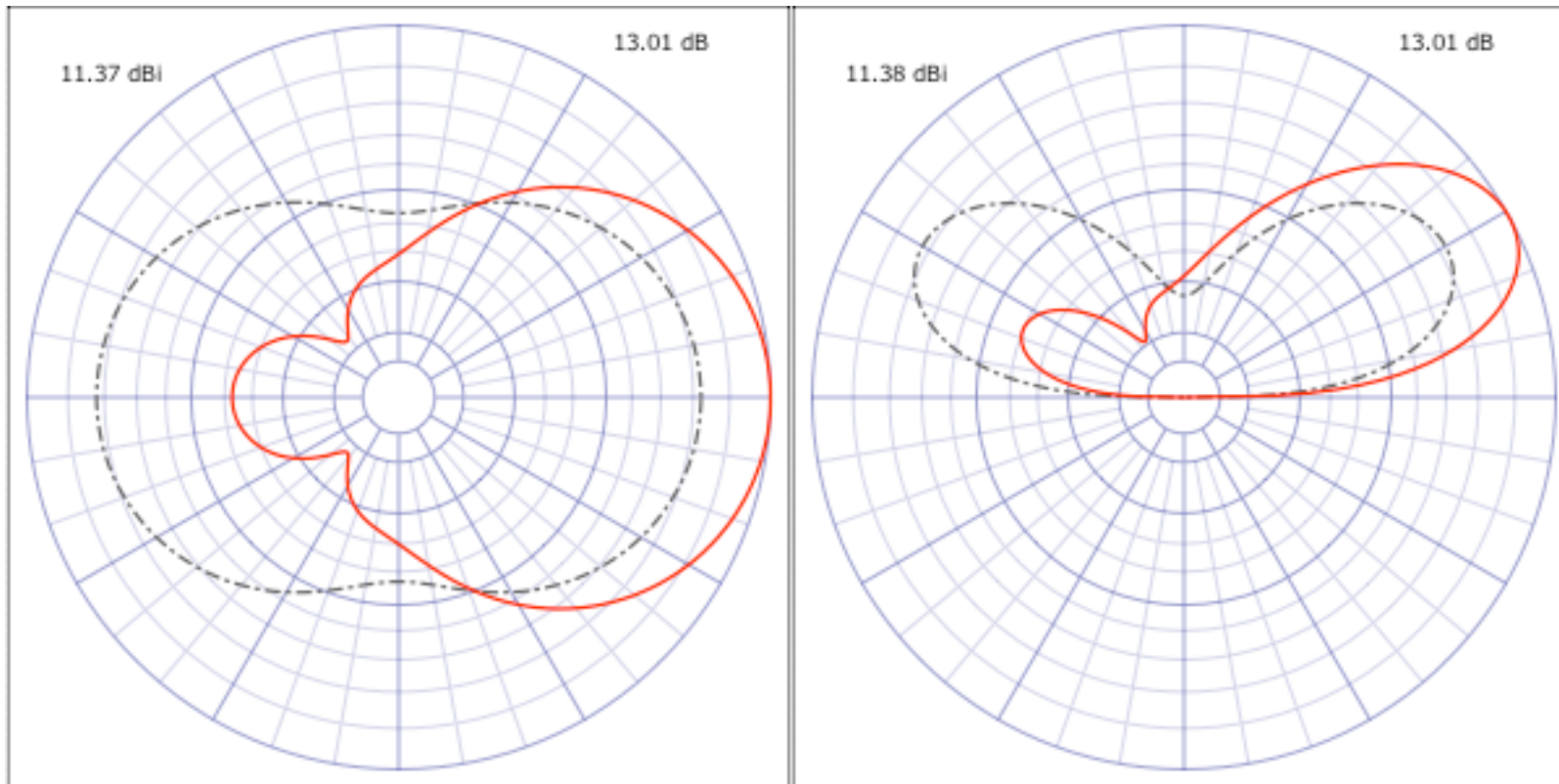

Figure 3 - Array Radiation Patterns at 7.125 MHz (Red is array, dashed line is dipole)

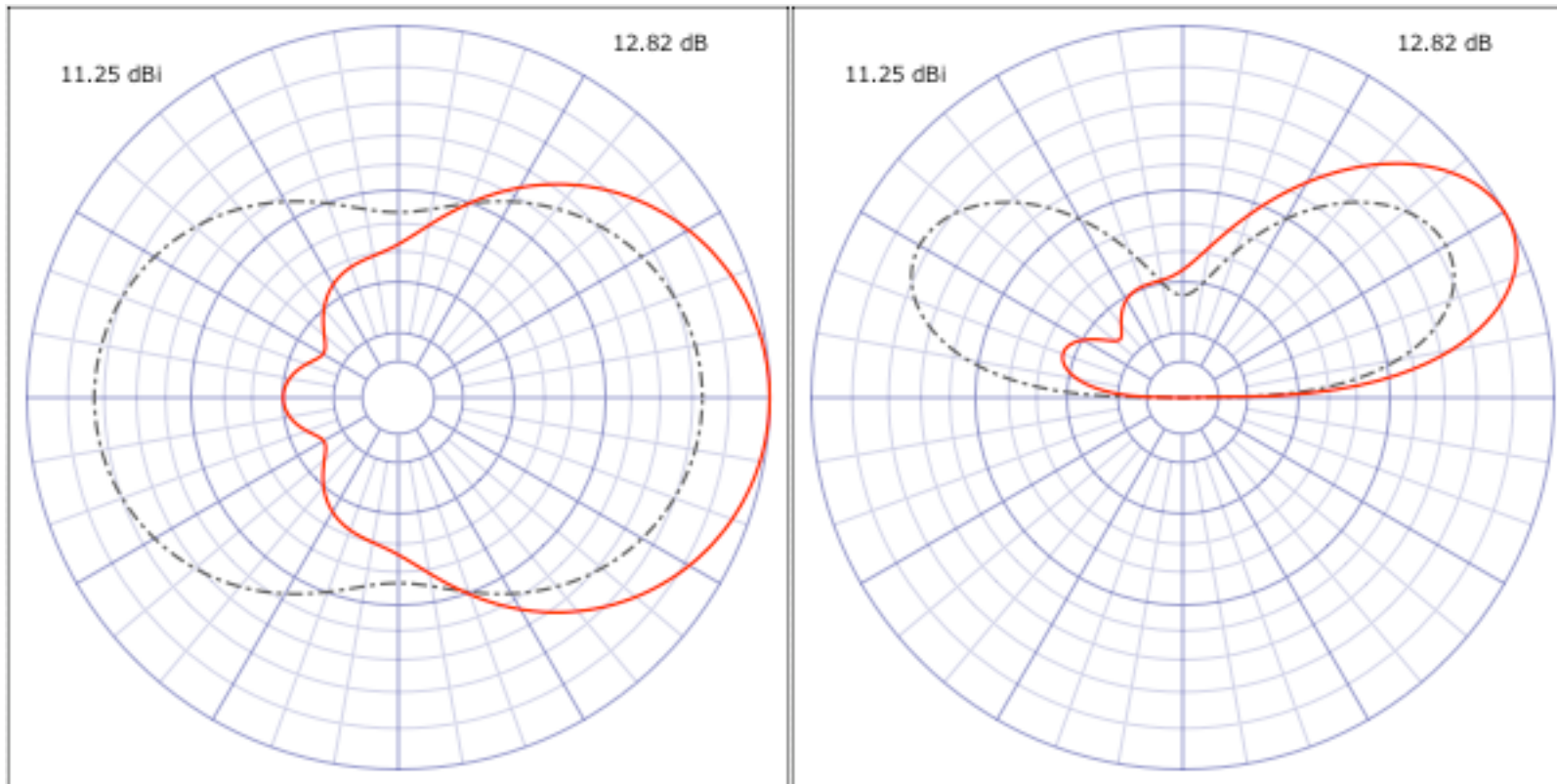

Figure 4 - Array Radiation Patterns at 7.160 MHz (Red is array, dashed line is dipole)

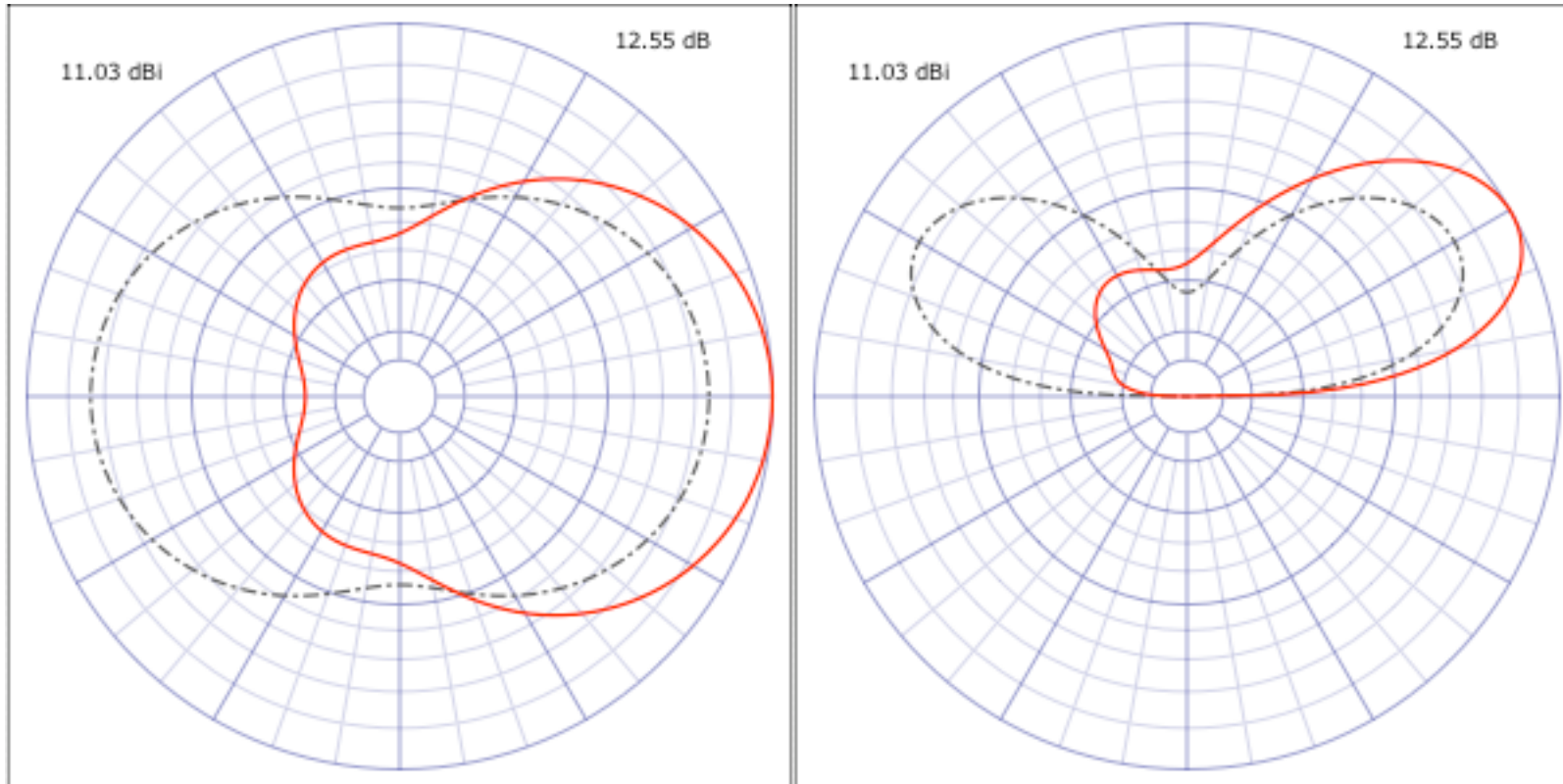

Figure 5 - Array Radiation Patterns at 7.2 MHz (Red is array, dashed line is dipole)

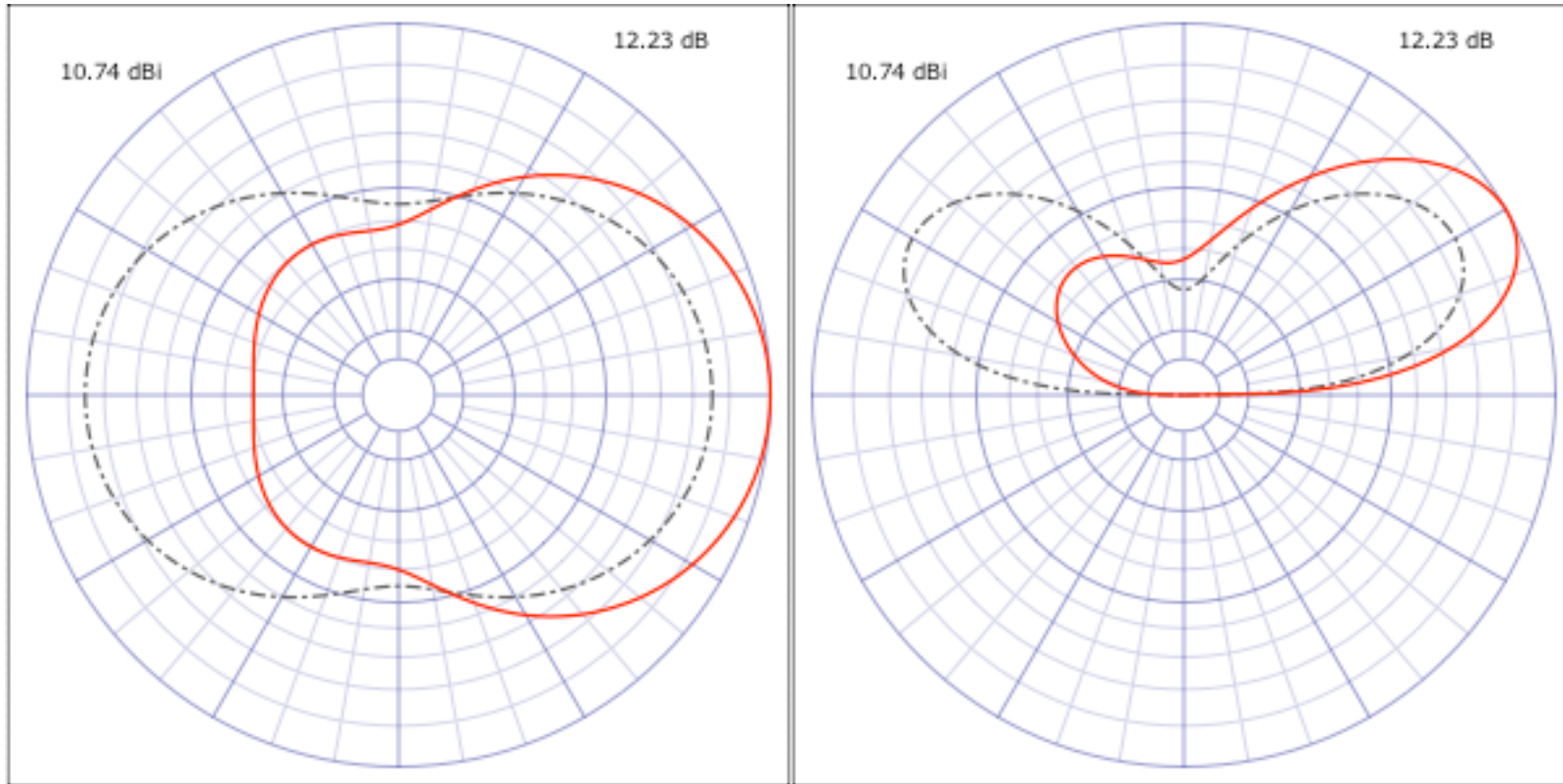

Figure 6 - Array Radiation Patterns at 7.25 MHz (Red is array, dashed line is dipole)

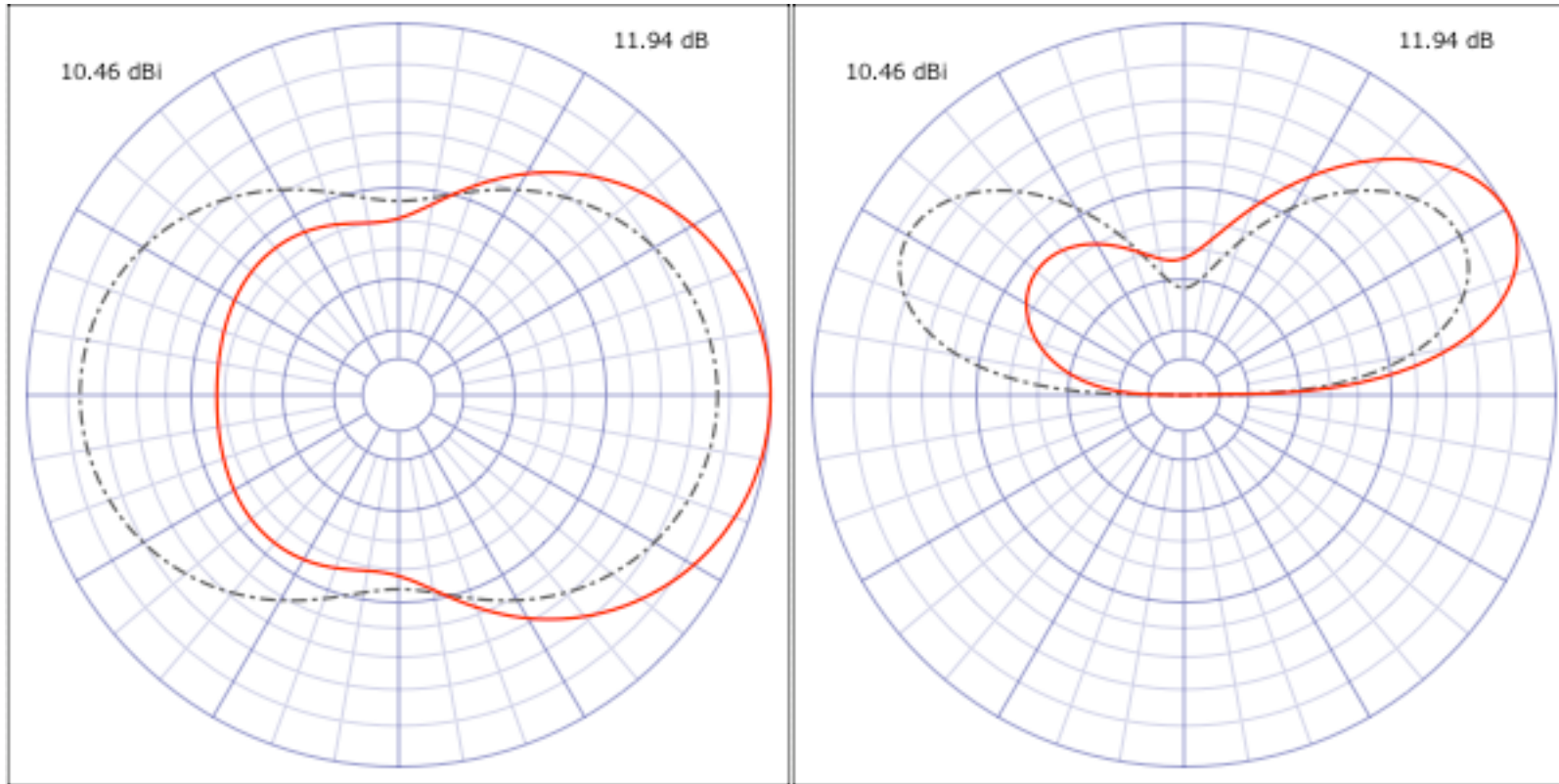

Figure 7 - Array Radiation Patterns at 7.3 MHz (Red is array, dashed line is dipole)